

# Users Guide to Adhesives

---

# Contents

## **Part 1 Assessment of bonding**

- Advantages of adhesive bonding
- Limitations
- Modern adhesives: types and main characteristics
- Designing a bonded joint
- Determination of dimension of simple lap joint
- Essentials for the bonding process
- Combination joints

## **Part 2 Essential stages of the pre-treatment process**

- Surface preparation
- Degreasing
- Abrading
- Pre-treatments for particular materials
- Special pre-treatments for maximum bond performance
- Essentials for chemical pre-treatments
- Metals

# User's Guide to Adhesives

## Introduction

Almost everything that is made by industry has component pieces, and these have to be fixed together. Often mechanical connections are chosen, such as screws, rivets or spot welds. However, engineers now often choose to use adhesive bonding. This joining technique is well proven and capable of replacing or supplementing mechanical fixing methods and has advantages which include:

- Reduced component and/or assembly costs
- Improved product performance and durability
- Greater design freedom
- Less finishing operations

This guide sets out to remove the reservations that engineers sometimes have about adhesives. It includes a survey of modern adhesives and shows how joints should be designed and pre-treated in order to make best use of adhesive bonding.

The guide comes from the inventors of adhesives capable of bonding metals. Our Araldite® trade name is known world wide in industry and in the home.

## A word about adhesives

What are we doing when we seek to use an adhesive? The question is not new. Man has used adhesives or glues since the dawn of history. The ancient Egyptians attached veneers to furniture with glue. These early glues were all natural substances. Nowadays we use synthetic resins and polymers.

When we bond components together the adhesive first thoroughly wets the surface and fills the gap between. Then it solidifies. When solidification is completed the bond can withstand the stresses of use. The strongest adhesives solidify through chemical reaction and have a pronounced affinity for the joint surfaces. Adhesive bonding is sometimes called chemical joining to contrast it with mechanical joining.

## Designing to bond.

In order to get the best performance from an adhesive bond it is important to design the component for bonding rather than simply taking a design made for mechanical fixing.

Methods of application of the adhesive and the assembly of the components must always be considered at the design stage, together with the practical curing conditions, which affect the choice of adhesive type to be used.

A quality bond is produced when quality is considered at all stages of the design and production process.

# ASSESSMENT OF BONDING

## Part 1

### Advantages of adhesive bonding

**The bond is continuous:** On loading, there is more uniform distribution of stresses over the bonded area. The local concentrations of stresses present in spot welded or mechanically fastened joints are avoided. Bonded structures can consequently offer a longer life under load.

**Stiffer structures:** The bonded joint – being continuous – produces a stiffer structure. Alternatively, if increased stiffness is not needed, the weight of the structure can be decreased while maintaining the required stiffness.

**Improved appearance:** Adhesive bonding gives a smooth appearance to designs. There are no protruding fasteners such as screws or rivets, and no spot-welds marks.

**Complex assemblies:** Complex assemblies that cannot be joined together in any other feasible way with adhesives. Composite sandwich structures are a typical example.

**Dissimilar materials:** Adhesives can join different materials together – materials that may differ in composition, moduli, coefficients of expansion, or thickness.

**Reduced corrosion:** The continuous adhesive bond forms a seal. The joint is consequently leak proof and less prone to corrosion.

**Electrically insulating:** The adhesive bond can provide an electrically insulating barrier between the surfaces.

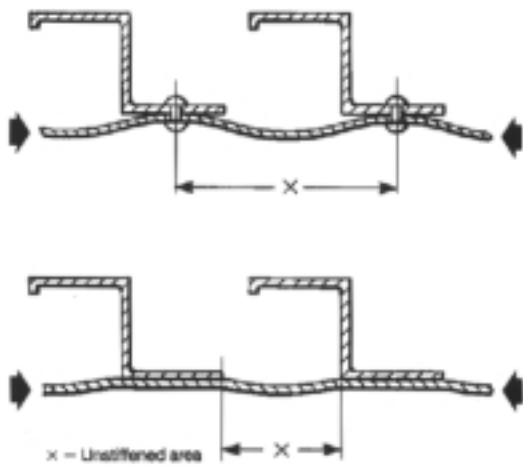

Fig.1 Stiffening effect – bonding and riveting compared

The diagram shows how a joint may be designed to take advantage of the stiffening effect of bonding.

Adhesives form a continuous bond between the joint surfaces. Rivets and spot welds pin the surfaces together only at localised points. Bonded structures are consequently much stiffer and loading may be increased (by up to 30 – 100%) before buckling occurs.

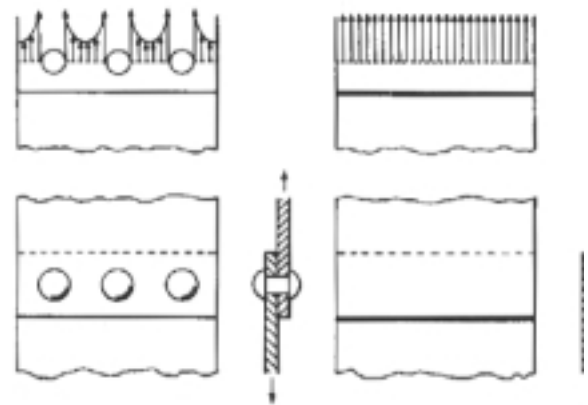

Fig. 2 Stress distribution in loaded joints

The riveted joint on the left is highly stressed in the vicinity of the rivets. Failure tends to initiate in these areas of peak stress. A similar distribution of stress occurs with spot welds and bolts.

The bonded joint on the right is uniformly stressed. A continuous welded joint is likewise uniformly stressed but the metal in the heated zone will have undergone a change in strength.

**Reduced stress concentrations:** The bonded structure is a safer structure because, owing to the fewer and less severe concentrations of stresses, fatigue cracks are less likely to occur. A fatigue crack in a bonded structure will propagate more slowly than in a riveted structure – or even in a machined profile because the bond-lines act as a crack stopper.

**Joining sensitive materials:** Adhesive bonding does not need high temperatures. It is suitable means for joining together heat-sensitive materials prone to distortion or to a change in properties from the heat of brazing or welding.

**Vibration damping:** Adhesive bonds have good damping properties. The capacity may be useful for reducing sound or vibration.

**Simplicity:** Adhesive bonding can simplify assembly procedures by replacing several mechanical fasteners with a single bond, or by allowing several components to be joined in one operation.

Adhesive bonding may be used in combination with spot welding or riveting techniques in order to improve the performance of the complete structure. All these advantages may be translated into economic advantages: improved design, easier assembly, lighter weight (inertia overcome at low energy expenditure), longer life in service.

## Limitations

**Temperature resistance:** Adhesives are drawn from the class of materials which we know as 'polymers', 'plastics' or 'synthetic resins'. They have the limitations of that class. They are not as strong as metals. (the difference is offset by the increased surface contact area provided by the bonded joints). With increasing temperature the bond strength decreases, and the strain properties of the adhesive move from elastic to plastic. This transition is usually in the temperature range 70 – 220°C: the transition temperature depends on the particular adhesive.

**Chemical resistance:** The resistance of bonded joints to the in-service environment is dependent on the properties of the polymer from which the adhesive is made. Possible exposure of the bonded structure to oxidising agents, solvents, etc., must be borne in mind when selecting the adhesive type to use.

**Curing time:** With most adhesives maximum bond strength is not produced instantly as it is with mechanical fastening or with welding. The assembled joint must be supported for at least part of the time during which the strength of the bond is building up. The quality of the bond may be adversely affected if, in the bonding process, the surfaces are not readily wetted by the adhesive.

**Process controls:** Ensuring consistently good results may necessitate the setting up of unfamiliar process controls. A badly made joint is often impossible to correct.

**In service repair:** Bonded assemblies are usually not easily dismantled for in-service repair.

## Modern adhesives: types and main characteristics

Modern adhesives are classified either by the way they are used or by their chemical type. The strongest adhesives solidify by a chemical reaction. Less strong types harden by some physical change. Key types in today's industrial scene are as follows.

**Anaerobics:** Anaerobic adhesives harden when in contact with metal and air is excluded, e.g. when a screw is tight in a thread. Often known as 'locking compounds' or 'sealants', they are used to secure, seal and retain turned, threaded, or similarly close-fitting parts. They are based on synthetic resins known as acrylics. Due to the curing process, anaerobic adhesives do not have gap-filling capability but have advantage of relatively rapid curing.

**Cyanoacrylates:** A special type of acrylic, cyanoacrylate adhesives cure through reaction with moisture held on the surfaces to be bonded. They need close-fitting joints.

Usually they solidify in seconds and are suited to small plastic parts and to rubber. Cyanoacrylate adhesives have relatively little gap-filling capability but can be obtained in liquid and thixotropic (non-flowing) versions.

**Toughened Acrylics/Methacrylates:** A modified type of acrylic, these adhesives are fast-curing and offer high strength and toughness. Supplied as two parts (resin and catalyst), they are usually mixed prior to application, but specialised types are available which are applied by separate application: resin to one bond surface, catalyst to the other. They tolerate minimal surface preparation and bond well to a wide range of materials. The products are available in a wide range of cure speeds and as liquids or pastes which will gap-fill up to 5mm.

**UV curable adhesives:** Specially modified acrylic and epoxy adhesives, which can be cured very rapidly by exposure to UV radiation. Acrylic UV adhesives cure extremely rapidly on exposure to UV but require one substrate to be UV transparent. The UV initiated epoxy adhesives can be irradiated before closing the bondline, and cure in a few hours at ambient temperature or may be cured at elevated temperature.

**Epoxies:** Epoxy adhesives consist of an epoxy resin plus a hardener. They allow great versatility in formulation since there are many resins and many different hardeners. They form extremely strong durable bonds with most materials. Epoxy adhesives are available in one-part or two-part form and can be supplied as flowable liquids, as highly thixotropic products with gap-filling capability of up to 25mm, or as films.

**Polyurethanes:** Polyurethane adhesives are commonly one part moisture curing or two-part. They provide strong resilient joints, which are resistant to impacts. They are useful for bonding GRP (glassfibre-reinforced plastics) and certain thermoplastic materials and can be made with a range of curing speeds and supplied as liquids or with gap-filling capability of up to 25mm.

**Modified Phenolics:** The first adhesives for metals, modified phenolics now have a long history of successful use for making high strength metal-to-metal and metal-to-wood joints, and for bonding metal to brake-lining materials. Modified phenolic adhesives require heat pressure for the curing process.

**The above types set by chemical reactions. Types that are less strong, but important industrially, are as follows:**

**Hot Melts:** Related to one of the oldest forms of adhesive, sealing wax, today's industrial hot melts are based on modern polymers. Hot melts are used for the fast assembly of structures designed to be only lightly loaded.

**Plastisols:** Plastisol adhesives are modified PVC dispersions which require heat to harden. The resultant joints are often resilient and tough.

**Rubber adhesives:** Based on solutions of latexes, rubber adhesives solidify through loss of solvent or water. They are not suitable for sustained loading.

**Polyvinyl Acetates (PVAs):** Vinyl acetate is the principal constituent of the PVA emulsion adhesives. They are suited to the bonding of porous materials, such as paper or wood, and general packaging work.

**Pressure-sensitive adhesives:** Suited to use on tapes and labels, pressure-sensitive adhesives do not solidify but are often able to withstand adverse environments. They are not suitable for sustained loading.

**No one company supplies all these types of adhesives. Each supplier specialises in particular types. Vantico supplies many industries with epoxy, polyurethane, modified phenolic, toughened methacrylate and UV curable acrylic adhesives under the tradenames Araldite®, Epibond®, Epocast® and Uralane®.**

### Designing a bonded joint

It is important that bonded articles are designed with bonding in mind, rather than simply bonding a design made for welding or mechanical joining. When designing

bonded joints the considerations include:

- Joint geometry
- Adhesive selection
- Mechanical properties of adhesive and adherent
- Stress in the joint
- Manufacturing conditions

Bonded joints may be subjected to tensile, compressive, shear or peel stresses, often in combination. (See Figure 3). Adhesives are strongest in shear, compression and tension. They perform less effectively under peel and cleavage loading. A bonded joint needs to be designed so that the loading stresses will be directed along the lines of the adhesive's greatest strengths.

To indicate the performance of an Araldite, Epibond, Epocast or Uralane adhesive, the Vantico Instruction Sheet for the particular adhesive quotes the shear strengths and peel strengths obtained by standard test methods. For example, the standard test method for shear (ISO4587) uses a simple lap joint made from metal sheet, usually an aluminium alloy, 25mm wide with 12.5mm overlap. The mean breaking stress at room temperature will be in the range 5 to 45 N/mm<sup>2</sup> depending on the adhesive. At the top end of this breaking stress range, joints made from aluminium alloy sheet of up to 1.5mm thickness will yield or break in the metal. (The lap joint is only one of several different types of bonded joint).

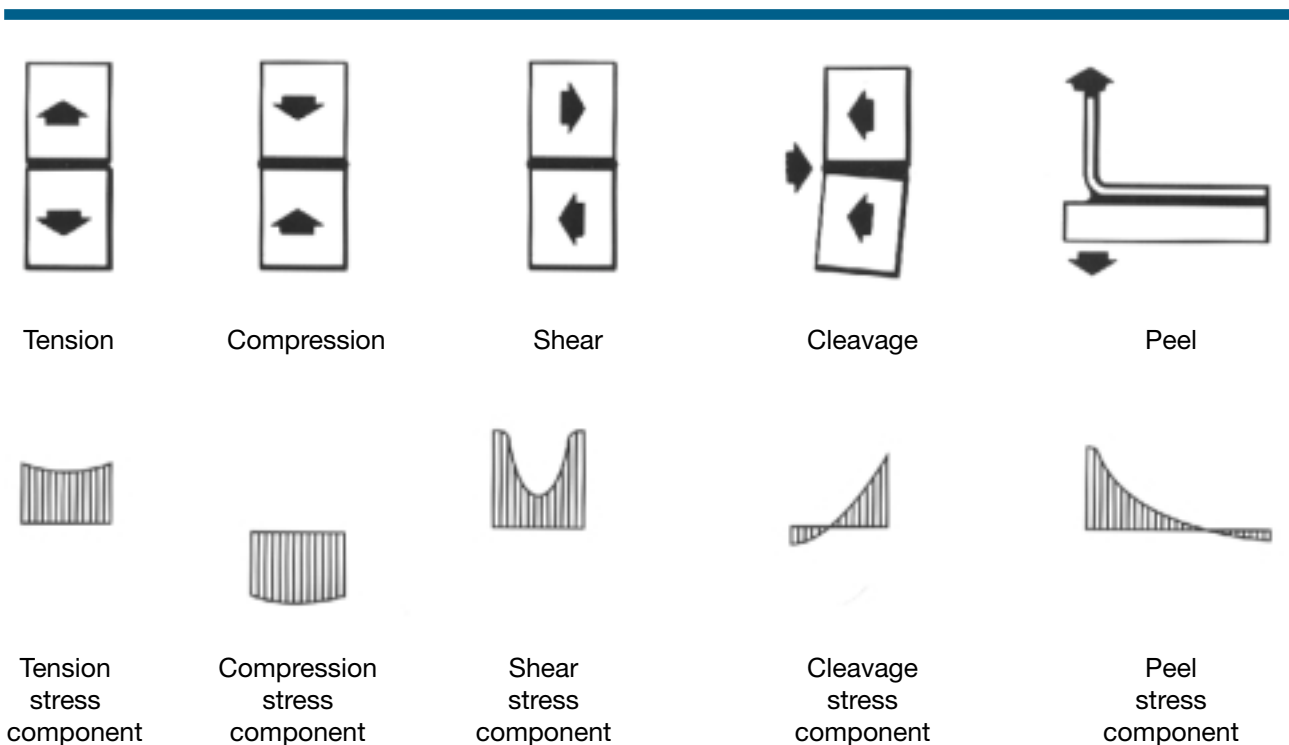

**Fig.1 Loading conditions**

A bonded joint can be loaded in five basic ways (shown in the diagram). Cleavage and peel loading are the most taxing: they concentrate the applied force into a single line of high stress. In practice a bonded structure has to sustain a combination of forces. For maximum strength, cleavage and peel stresses should be as far as possible designed out of the joints.

The breaking load of a lap joint is proportional to its width, but not to its overlap length. Although the breaking load will increase as overlap length is increased, the mean breaking stress will be reduced.

A method of determining the best dimensions for a simple lap joint is described in Simple Lap Joints: Determination of dimensions (page 10).

The strength of a joint is a complex function of the stress concentrations set up by the load. In a simple lap joint made from thin metal sheet there are two sorts of stress: shear and peel. Both the shear and peel stresses vary along the length of the joint, with concentrations at the ends. Alternative joint designs are shown in Figure 4 where these stresses are more evenly distributed. The efficiency gained results in joints of greater strength.

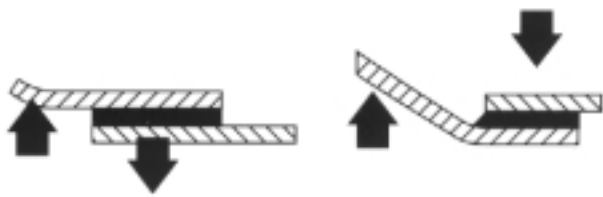

A peel joint can be designed such that the forces acting upon it become compression forces, making a much stronger joint.

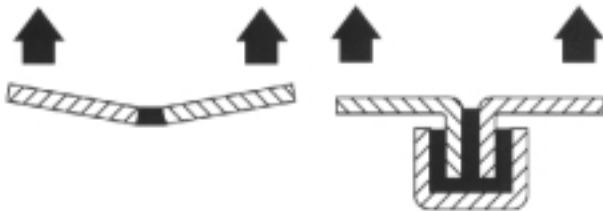

Weak cleavage joints can be strengthened through design, in this instance by adding a U-section to the previously bent sheet.

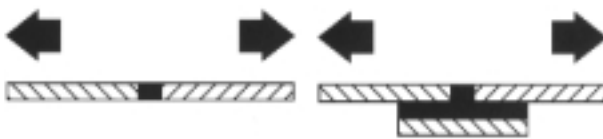

By adding reinforcing plates to this butt joint, the forces run along a much stronger shear joint.



A similar effect is produced by sleeving this cylindrical butt joint.

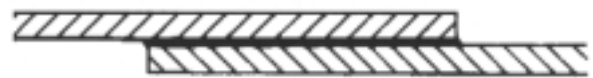

Simple lap joint good



Tapered lap joint very good



Scarf joint excellent



Stepped lap joint very good

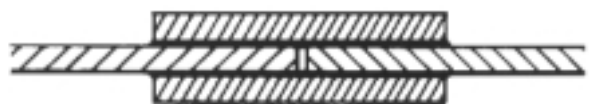

Double strap joint/double lap joint very good

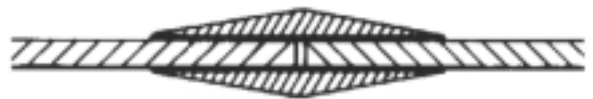

Tapered double strap joint excellent

**Fig.4 Basic bonded joints between strip/sheet metals**

The basic types of bonded joints are shown diagrammatically. In practical structures two or more basic types may be used in combination – and the relative dimensions (and areas of bonded surface) of the joints may vary from those shown in the diagrams.

Tapering of the ends of lap joints or scarf joints serves to distribute the stress more uniformly and reduce stress concentration.

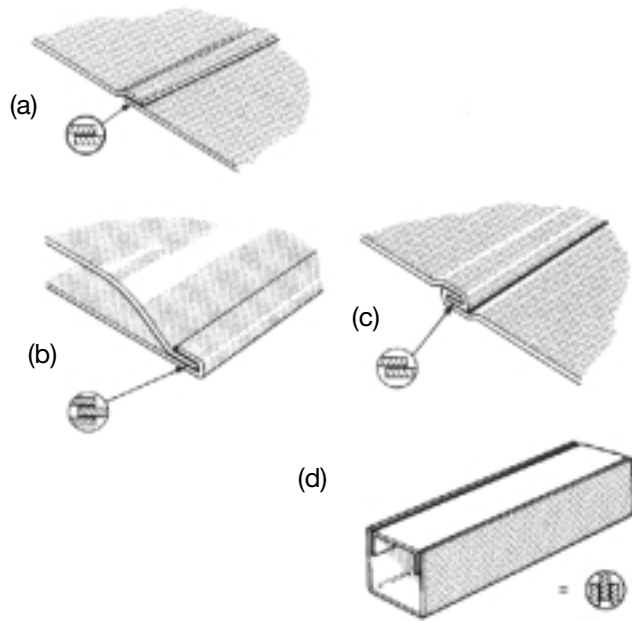

**Fig.5 Practical bonded joints between sheet materials**

Certain metals, especially mild steel, are easily bent or folded to form advantageous joints. (a) Shows a development from the simple lap joint: a toggled joint. (b) and (c) show further developments. Closed box structures (d) from formed sheet metal are easily produced using this folding and bonding technique to join the edges.

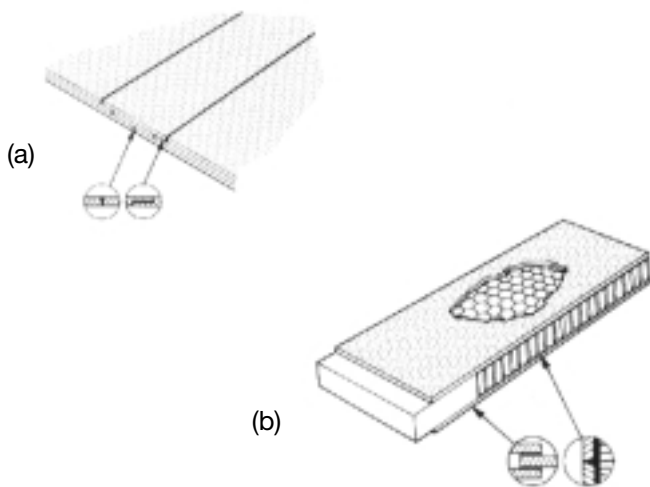

**Fig.6 Bonding of multi-layer structures**

Multi-layer structures may be built up by adhesive bonding and may also be bonded to other parts. In (a) a multi-layer fibre-reinforced plastics laminate is joined to its neighbour by a multi-stepped lap joint. In (b) an edge member is bonded into a sandwich panel. On loading, the stresses will be transferred into the panel. The honeycomb core is itself assembled and bonded to the facing sheets with adhesives.



**Fig.7 Joints using profiles**

Sheets or plates that cannot be bent and folded may be bonded together by means of purpose-made profiles. Tapering removes the high stress concentrations caused by abrupt change in section.

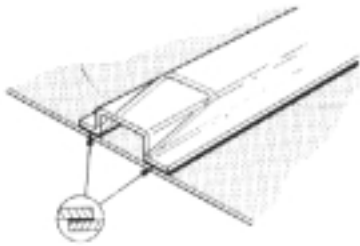

**Fig.8 Stiffening of large thin sheets**

Large sheets of thin-gauge material (metal or plastics) may be stabilised by bonding stiffeners made of the same material in similar gauge. The diagram shows a 'top hat' stiffener. Towards the edge of the sheet, the stiffener may be cut away (as shown) in order to reduce stress concentrations. The effect is similar to that of the scarf joint in Fig.4.

---

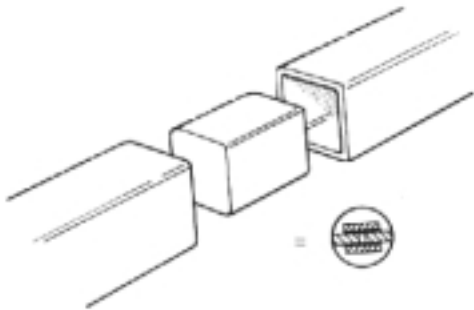

(a)

**Fig.9 Bonded frameworks**

Framework structures of square or round tubes, or simple profiles, may utilise plugs (a), angles (b), or bosses (c) at the joints. Use of these additional pieces greatly increases the area of bond surface at the joint.

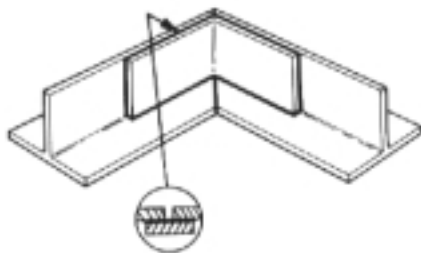

(b)

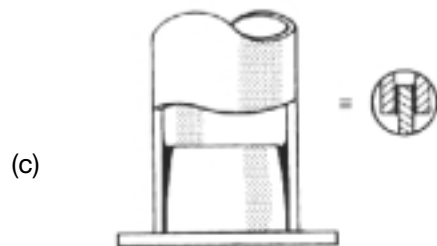

(c)

---

## The durability of a bonded joint

The durability (the long-term performance) of a bonded joint depends on the properties both of the adhesive and of the materials being joined.

The adhesive will be affected by high temperatures, by powerful solvents, or by water. The durability of the joint will also depend on the effects of these agents on the materials being joined. Above all, it will depend on the condition of the joint surfaces when the bond was made. The best joints are made when the surfaces are absolutely clean and have good affinity for the adhesive. This necessitates control of pretreatment of the surfaces. A poor surface condition usually results in a relatively low initial strength and a reduced durability. A thick bond-line gives lower initial strength. (See Figure 10.) With most types of adhesive, the application of heat to complete the curing process improves both initial strength and durability. The user will have to judge the level of control of these factors necessary to produce a bonded joint satisfactory for the expected service conditions. For many applications a good and sufficient durability is obtained with easily attained levels of surface control (or pretreatment), bond-line thickness and curing schedule.

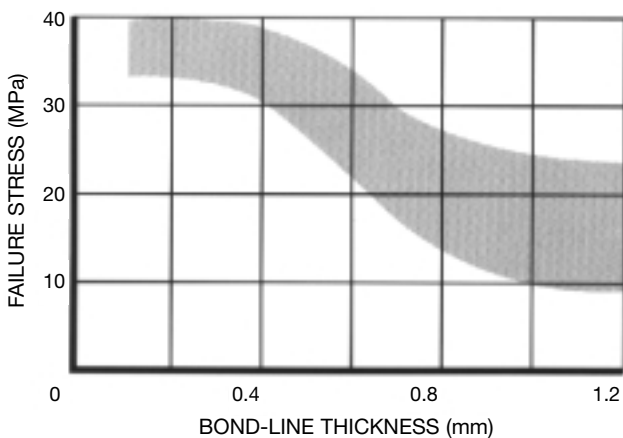

**Fig.10 Bond-line thickness v. shear strength**

Shear strength decreases if the layer of adhesive is thick. The effect of increasing bond-line thickness in simple lap joints made with hot-cured epoxy adhesives is shown in the diagram. Adhesive strength at the interface is by its nature greater than the cohesive strength within the adhesive. The diagram shows that in this adhesive the drop in strength occurs in the range 0.4 to 1.0 mm. In thicknesses greater than 1.0 mm shear strength is approximately constant. The exact shape of the curve depends on the characteristics of the adhesive. Toughened adhesives will maintain higher values in thicker bondlines while more rigid adhesives will reduce more quickly. The optimum bond-line thickness is in the range 0.1 to 0.3mm. In very thin bond lines there is risk of incomplete filling of the joint due to contact between high points on the joint surfaces.

The bonded joints may need to resist sustained loads, which are either static or vibrational. Joint designs in which peel stresses are at a minimum give the best durability. The fatigue testing (by standard methods) of simple lap shear joints made with epoxy adhesives will often give failure values of ca 30% of the short-term measured breaking load. (See Figure 11.)

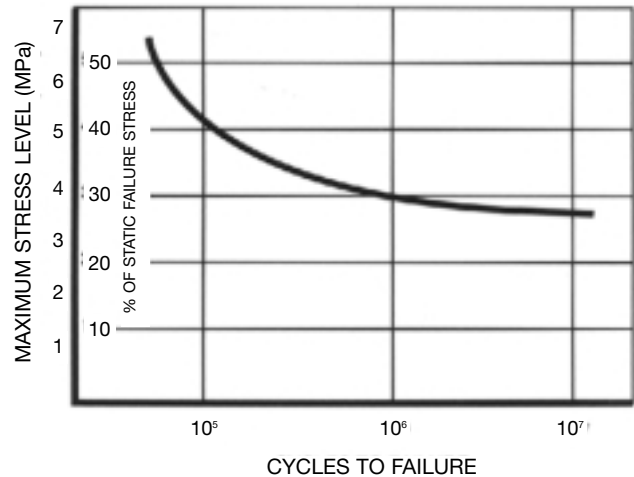

**Fig.11 Fatigue strength (tensile) of lap joints**

Fatigue strength of simple lap joints made with a cold-cured epoxy adhesive and tested to DIN 53 285. In this test programme the failure stress of control joints under static loading was 13 Mpa. The diagram shows that under fatigue loading the joints required to sustain 10<sup>6</sup> test cycles should not be stressed higher than 4.1 Mpa per cycle.

## Determination of dimensions of simple lap joints

The shear strength of simple lap joint (Fig 12) depends on the nature of the metal, the adhesive, the thickness of the metal and the area of overlap.



**Fig.12 Simple lap shear joint**

$l$  = overlap;  $t$  = metal thickness

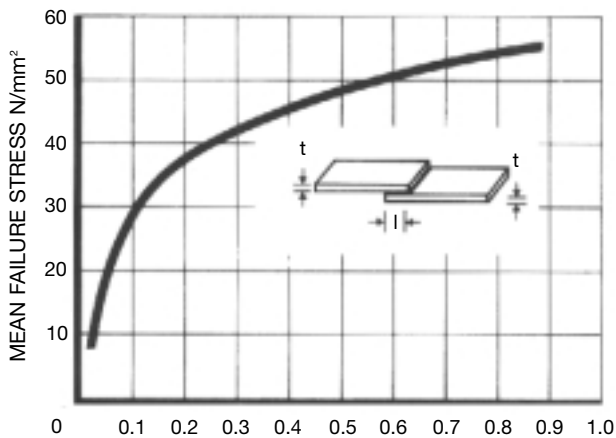

**Fig.13 Correlation diagram between shear strength and t/l of simple lap joints**

The diagram relates the dimensions of the joint, the shear stress in the adhesive and the tensile stress in the metal\*

\*The curve shown in Fig.13 was established from a test programme carried out on simple lap joints of BS 1470-HS30 aluminium alloy bonded with hot-cured Araldite epoxy adhesive.

Given the loading required and the metal and adhesive to be used, it is possible to predict:

1. Optimum overlap on metals of given thickness.
2. Optimum metal thickness for given overlap.

This overlap and thickness may be rapidly determined from a diagram based on results from one test programme.

The test – to determine mean shear strengths of joints of various overlaps (l) and metal thickness (t) – must be sufficient to plot a curve of shear strength against t/l. A curve established in this way is shown in Fig.13.

Any particular point on an established curve represents (for lap joints made with metal and adhesive to the same specifications as used in the test programme) the state of stress in a particular joint and shows the relationship between the dimensions of the joint (horizontal axis), the mean shear stress in the adhesive (vertical axis) and the mean tensile stress in the metal (slope of a straight line from the origin to the point).

Optimum overlap (l) is determined by using the diagram together with the formula:

$$\tau = \sigma \cdot \frac{t}{l}$$

This formula is derived from –

The known design requirements:

- P**= load per unit width of joint
- t** = sheet thickness (t= thickness of thinner sheet in joints made of sheets of different thickness)

These establish:

$$\sigma = \text{mean tensile stress in the metal} = \frac{P}{t}$$

and by definition:

$$\tau = \text{mean shear stress in the joint} = \frac{P}{l}$$

$$\text{Substituting for } P \text{ gives: } \tau = \sigma \cdot \frac{t}{l}$$

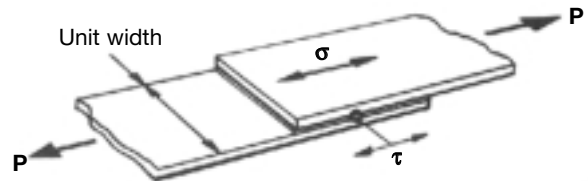

**Fig.14 Conventional designs for stresses in a lap joint**

Optimum overlap (l) is determined as follows:

1. Calculate s from **P** and **t**.
2. Starting from 0, mark on the diagram the straight line whose slope  $\left(\frac{\tau}{t}\right)$  is given by  $\sigma$ .
3. Where the straight line cuts the curve, read off the value for  $\tau$
4. Having determined  $\sigma$  and  $\tau$ , and knowing **t**, substitute these values in:

$$\tau = \sigma \cdot \frac{t}{l}$$

and calculate optimum overlap **l**.

Deviation from the optimum overlap reduces the efficiency of the joint. Too small an overlap causes the joint to fail below the required loading, whereas too large an overlap may mean an unnecessarily large joint.

Optimum sheet thickness (t) is determined as follows:

1. Calculate  $\tau$  from **P** and **l**.
2. Where the value of t cuts the curve, read off the value for  $\frac{t}{l}$
3. Having determined  $\frac{t}{l}$  and knowing **l**, calculate optimum thickness **t**.

## Essentials for the bonding process

To make a successful bond, the adhesive must wet the material to be joined, fill the gap between the surfaces, and then fully harden.

With a two-part adhesive this means that resin and hardener must be correctly proportioned and thoroughly mixed together. The right amount of mixed adhesive needs to be placed and spread onto the bond area. Both these steps are aided by using automatic equipment. The simplest equipment dispenses adhesive from pre-filled cartridges (see Figure 15). Typical volumetric proportioning equipment, which meters, mixes and dispenses two-part epoxy adhesives is shown in Figure 16. Where highly viscous or thixotropic components are used, the metering units may be fed by special drum pumps. Similarly for one-part epoxy adhesives there are hand or air operated guns or applicators. Suitable equipment is advantageous in setting up a Quality Assurance Scheme for a bonding process.

Continuous production bonding also necessitates ensuring that the condition of the surfaces to be bonded is always the same. Unknown contaminants must be removed from the surfaces. A particular surface treatment may be needed in order to increase the affinity for the adhesive. Surface preparation can be a multi-step process. It usually includes mechanical abrasion and – to achieve optimum results – chemical etching.

In some cases known surface coverings, such as protective oils, may be absorbed by the adhesive in the bonding process – this ability is a characteristic of specially formulated oil-tolerant Araldite epoxy adhesives. In these cases the known covering material defines the surface condition.

The hardening or curing of reactive adhesives requires time. The time is shortened if heat can be applied. Furthermore, though with many two-part epoxy adhesives strong joints can be obtained by curing at room temperature (for 2 to 24 hours), higher curing temperatures – even a few degrees above room temperature – will raise the bond strength. With certain one-part epoxy adhesives curing temperatures may need to be as high as 180°C in order to obtain the best properties. Elevated temperature curing may be carried out using:

**Hot air ovens:** This is a practical method only when a large number of assemblies are in the oven at the same time or for continuous production lines. Heat transfer is relatively slow and affected by the assembly type and thickness. Infra-red ovens can also be used.

**Heated presses:** Steam or oil-heated platens can be used in flat bed presses with a rapid and controllable temperature rise. This method is ideal for production of large flat panels, e.g. for insulated container sides.

**Induction curing:** Magnetic field causes current to flow in a conductive substrate. The resistance to the current generates heat and cures the adhesive. This technique has been used where very fast heat up and cure is required.

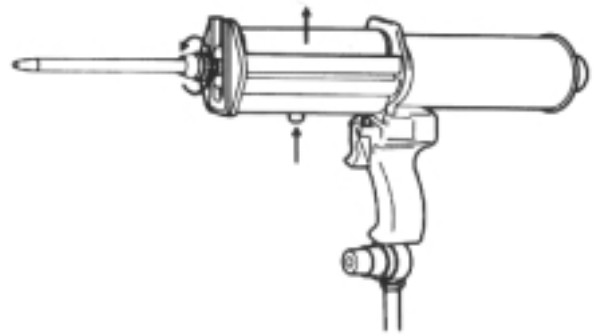

Fig.15 Handgun operated by compressed air

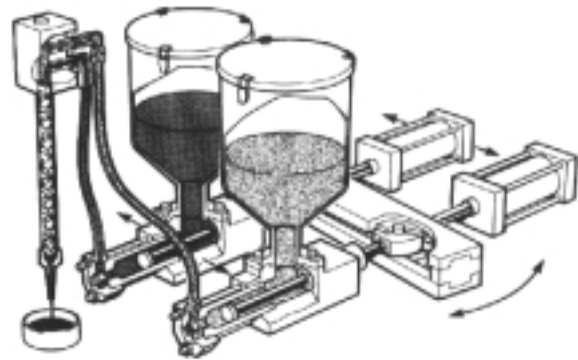

Fig.16 Metering and mixing machine for two-part epoxy adhesives

## Combination joints

Adhesives can be used in combination with other joining methods, in particular, riveting or spot welding. Rivets or welds at intervals along the bond-line not only act as locating and holding points during the time the adhesive cures but also increases the peel resistance of the joint. From the other viewpoint, that of the mechanical fastening, the presence of the adhesive improves the stiffness of the joint, distributes the stresses uniformly and it forms a seal. Adhesive bonding also increases the speed and reduces overall the noise of the joining process.

Araldite adhesives adhere firmly to most materials. Bonds of great strength are obtained after removal of grease and loose surface deposits, e.g. rust, from the surfaces to be joined, but when maximum strength and long-term durability are required a more thorough mechanical or a chemical pretreatment is recommended.

### Surface preparation

Surfaces are prepared by one of the following pretreatment procedures (listed in order of increasing effectiveness):

1. Degrease only.
2. Degrease, abrade and remove loose particles.
3. Degrease and chemically pretreat.

Care must be taken to avoid contaminating the surface during or after pretreatment. Contamination may be caused by finger marking – or by cloths, which are not perfectly clean – or by oil-contaminated abrasives – or by sub-standard degreasing or chemical solutions. Contamination may also be caused by other work processes taking place in the bonding area. Particularly to be excluded are oil vapours from machinery, spraying operation (paint, mould release-agent, etc.) and processes involving powdered materials.

Whatever the pretreatment procedure used, it is good practice to bond the surfaces as soon as possible after completion of the pretreatment – i.e. when surface properties are at their best.

If the scheduling of bonding operations on multi-part assemblies causes delay between pretreatment and bonding, optimum surface properties may be preserved by priming the bond surfaces immediately after pretreatment.

### Degreasing

Remove all traces of oil and grease as follows:

- (a) Suspend in halocarbon solvent\* vapour in a vapour degreasing unit.
- or
- (b) Immerse successively in two tanks each containing the same liquid halocarbon solvent\* acts as a wash, the second as a rinse.

\* **Halocarbon solvents** At the time of publication, legislation regarding halogenated solvents was changing. Users should contact the solvent suppliers for advice and must ensure compliance with local and national regulations governing their use.

or

- (c) Brush or wipe the joint surfaces with a clean brush or cloth soaked in clean proprietary commercial degreasing solvent. A wide range of proprietary solvent degreasing agents with low hazard ratings are now available.

or

- (d) Detergent degreasing. Scrub the joint surface in a solution of liquid detergent. Wash with clean hot water and allow to dry thoroughly – preferably in a stream of hot air.

or

- (e) Alkaline degreasing is an alternative method to the detergent degreasing. It is recommended to use proprietary products and follow manufacturer's instructions for use.

or

- (f) Ultrasonic degreasing may be employed when appropriate and is generally used for the preparation of small specimens.

### Abrading

Lightly abraded surfaces give a better key to adhesives than do highly polished surfaces. Abrasion treatment, if carried out, must be followed by a further treatment to ensure complete removal of loose particles. For example:

- (a) Repeat the degreasing operation (degreasing liquids must be clean),

or

- (b) Lightly brush with a clean soft brush, or – preferably
- (c) Blow with a clean dry (filtered) compressed air-blast. Abrasion can be carried out with abrasive paper, wire brushing or most effectively by grit-blasting.

### Pretreatments for particular materials

Most materials likely to require bonding in industrial practice are dealt with individually in detail in Publication No.15 – Guide to surface preparation and pretreatment. The information in this publication is intended only as an overview.

### Special pretreatments for maximum bond performance

The surface preparation described above, i.e. degreasing alone or degreasing followed by abrasion and removal of loose particles, is sufficient for most adhesive work, but to obtain maximum strength, reproducibility and long-term resistance to deterioration, a chemical or electrolytic pretreatment may be required.

Metal adherent surfaces are rarely of pure metal, but are a combination of oxides, sulphides, chlorides and other atmospheric contaminants resulting in a surface which is mechanically weak. Acid etching is a well-established method of removing metallic scale, in favour of forming an oxide layer, which is mechanically and chemically compatible with the adhesive. Hence, different acid treatments are applied to different metal adherends, for example, chromic acid for aluminium, sulphuric acid for stainless steel, and nitric acid for copper. Acid pretreatment can also be applied to certain plastics, e.g. chromic acid is used to surface treat polyolefins. (Details are given in Publication No.A15.)

Anodising has been exploited extensively by the aerospace industry as a surface pretreatment for aluminium and titanium alloys. The purpose of anodising is to deposit a porous oxide layer on top of the oxide layer formed after etching. The porous oxide layer enables adhesive (or primer) to penetrate the pores readily to form a strong bond. 'Hard' anodising is not an effective bonding pretreatment.

Application of a primer is another form of surface pretreatment mainly used for materials such as metals and ceramics. Generally, the primer is the final stage of a multistage pretreatment process. Some adherends have 'difficult to bond' surfaces (e.g. copper). The primer, which is formulated such that it represents a solvented version of the adhesive, readily wets the adherend. The adhesive, when applied to the primed surface, being chemically compatible, will establish a strong joint on curing.

### Essentials for chemical pretreatments

Care must be taken in the preparation of chemical pretreatment solutions, not only because of the handling hazards, but also because incorrect preparation may lead to bond strengths inferior to those that would have been obtained if there had been no chemical pretreatment.

Time of application is also critical: too short an application does not sufficiently activate the surfaces, whereas overlong application may build up chemical reaction products, which interfere with adhesion.

On completion of chemical pretreatment, thorough washing of the surfaces with plenty of clean water is standard practice. For the final rinse, the use of deionised (demineralised) water is recommended.

Surfaces should be bonded as soon as possible after pretreatment. Stability of the pretreated surfaces is limited.

## Metals

The wide range of individual alloy (and the variety of surface structures caused by different heat treatments) within each metal group precludes standardising on one pretreatment for each. The pretreatments listed in Publication No.A15 are well established but on occasions a different pretreatment may prove more effective. This can be shown only by comparative trials – using material from the batch of metal components to be bonded and the type of adhesive specified for the work. Additional data on pretreatment of metals is given in ISO 4588 and DEF standard 03-2/2.

## Thermosetting plastics

Mouldings, castings, laminates, etc. can usually be bonded without difficulty. To ensure good bond strength, all soil and residual release agents must be removed from the joint surfaces before the adhesive is applied. The surface must either be abraded with emery cloth or grit-blasted, or they must be cleaned with a solvent such as acetone, methyl ethyl ketone, etc. Abrading or grit-blasting is recommended for mouldings since their surfaces may otherwise repel the adhesive.

## Thermoplastics

These are often difficult to bond. Certain types permit only moderately successful bonding, and one and the same material may show considerable variation in properties, which determine the strength of a bond. Special adhesives have been developed, but they usually prove to be unserviceable when thermoplastics have to be bonded to materials such as wood, metal, etc. Araldite adhesives can be very useful in such cases even though their suitability for bonding thermoplastics is only limited. Pretreated thermoplastics for special applications (e.g. ski 'skins') are easily bonded with Araldite.

The grade of plastic and the manufacturing process used to make the component may influence the effectiveness of the pretreatment. It is advisable to establish by trial whether the pretreatment is improved by adjusting the specified time.

In addition to the normal mechanical and chemical methods of pretreatment, certain plastics can be pretreated using the following methods, all of which cause a change in the surface texture of the adherend. The change is brought about by the interaction of highly energised species with the adherend surface. These pretreatment methods have been applied to metals and in particular composites and plastics.

**A low pressure plasma** is an excited gas generated by applying a high frequency and high voltage between electrodes in a low pressure chamber. The advantage of this method is that it allows treatment of adherends by different plasmas of argon, ammonia, oxygen or nitrogen making the process suitable for a range of substrate types. Plasmas are generally used to activate the surfaces of adherends.

If instead a plasma is created in air at atmospheric pressure, the air when isolated appears as a blue/purple glow with faint sparking, and is termed a **corona**. Corona treatments are usually applied for preparing thin polymer films and composite laminates.

The effect of a **flame treatment** is to oxidise the adherend, which produces polar groups creating a surface better suited to wetting by the adhesive. This method of surface pretreatment has been applied successfully to polyethylene/polypropylene. The variables of flame treatment include type of gas, gas/air (oxygen) ratio, the rate of flow of mixture, exposure time and distance between flame and adherend.

All these methods have limited stability due to adsorption of airborne contaminants and vary from hours to weeks according to substrate. Further information can be found in ISO 13895.

Araldite adhesives are simple to use, but to ensure successful bonding the directions given in the instructions supplied with the adhesive must be strictly observed.

In particular:

1. Joint surfaces must be degreased and when necessary, pretreated.
2. Resin and hardener must be correctly proportioned and thoroughly mixed together.
3. Adhesive must be applied in the correct controlled thickness.
4. Jigs or other fixtures must be used to prevent the bond surfaces from moving relative to one another during the curing process.
5. Though only light pressure is needed, it should be applied as evenly as possible over the whole bond area. Excessive pressure leaves the joint starved of adhesive.
6. Curing temperatures and curing time must be correct (in accordance with the supplier's recommendations).

## Caution

### Acids, caustic soda etc.

Concentrated acids, oxidising agents (e.g. chromium trioxide, dichromates) and caustic soda are highly corrosive chemicals. Spillages and splashes can cause severe damage to eyes and skin, and attack ordinary clothing where these chemicals are used.

The manufacturer's handling precautions must be observed.

### Araldite, Epocast, Epibond and Uralane

Araldite, Epocast, Epibond and Uralane resins and hardeners are generally quite harmless to handle provided that certain precautions normally taken when handling chemicals are observed. The uncured materials must not, for instance, be allowed to come into contact with foodstuffs or food utensils, and measures should also be taken to prevent the uncured materials from coming in contact with the skin, since people with particularly sensitive skin may be affected. The wearing of impervious rubber or plastic gloves will normally be necessary; likewise the use of eye protection. The skin should be thoroughly cleansed at the end of each working period by washing with soap and warm water. The use of solvents is to be avoided. Disposable paper towels – not cloth towels – should be used to dry the skin. Adequate ventilation of the working area is recommended. These precautions are described in greater detail in Publication No.24264\* and in the Safety Data Sheets\* for the individual products.

The Araldite UV range is likewise generally harmless to handle provided that direct contact with the adhesive is avoided and good ventilation is maintained.

\* These publications are available on request and should be referred to.

*All recommendations for use of our products, whether given by us in writing, verbally, or to be implied from the results of test carried out by us, are based on the current state of our knowledge. Notwithstanding any such recommendations the Buyer shall remain responsible for satisfying himself that the products as supplied by us are suitable for his intended process or purpose. Since we cannot control the application, use or processing of the products, we cannot accept responsibility therefor. The Buyer shall ensure that the intended use of the products will not infringe any third party's intellectual rights. We warrant that our products are free from defects in accordance with and subject to our general conditions of supply.*

*Mandatory and recommended industrial hygiene procedures should be followed whenever our products are being handled and processed. For additional information, please consult the corresponding product safety and data sheets.*

**Vantico Ltd**

Duxford

Cambridge CB2 4QA

U.K.

Tel: +44 (0)1223 493000

Fax +44 (0)1223 493002

[www.vantico.com/adhesives](http://www.vantico.com/adhesives)

**vantico**